

# CAT 1

## Workstation Systems

**COLLECTIONS**

AXEL – Frames and Tiles

**General Information**

**Tables**

- 23x48.7 adjustable table including 2 grommets (left/right) (see page 9 and 10)

**Surface Finish**

- 1" laminate surface
- 1.5 mm ABS thick edge banding

**Panels**

- "Beam" type system - see technical sheet p.11
  - Painted metal frame (30H) and laminated legs
  - Covering with laminated tile (12H)
  - 18H felt screen installed over the frame

**Electricity**

- 4 circuit / 8 wire system
- Ground power supply including a wire cover
- Each station includes:
  - 2 duplexes (4 single sockets)
  - 1 telecommunications plate



PLAN VIEW

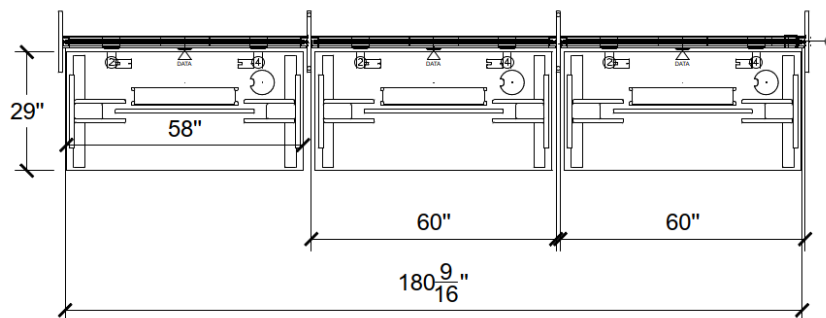

**COLLECTIONS**

AXEL – FRAMES AND TILES

**GENERAL INFORMATION**

**Tables**

- 23x48.7 adjustable table including 1 grommet (center)(see page 9 and 10)

**Surface Finish**

- 1" laminate surface
- 1.5 mm thick ABS edge banding

**Panels**

- "Beam" type system see technical sheet p.11
  - Painted metal frame 30H) and laminated legs
  - Covered with laminated tile (12H)
  - 18H frosted acrylic screen installed over the frame

**Electricity**

- 4 circuits / 8 wire system
- Ground power supply including a wire cover
- Each station includes :
  - 2 duplexes (4 single sockets)
  - 1 telecommunications plate



PLAN VIEW

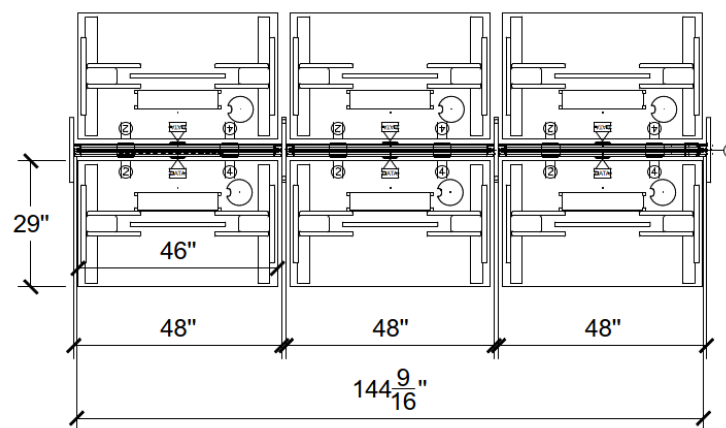

### ELECTRICAL COMPONENTS & COMMUNICATIONS

#### 1. Electrical system

1. The electrical system is certified and complies with the National Electrical Code. building. (REF. UL183).
2. 4 circuits electrical system comprising 8 wires.
3. Power conductors (12 AWG) share a ground (12 AWG) and neutral (10 AWG).
4. The fourth circuit is dedicated and isolated and is served by: its power conductor, its grounding and its isolated neutral.
5. Nominal power for a single-phase current circuit connected to the ground: 120/240 Volt, 20 Amp.
6. Nominal power for a three-phase current circuit connected to the ground : 120/208 Volt, 20 Amp.

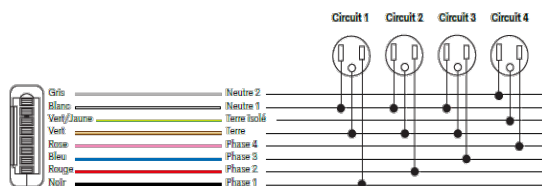

#### 7. General View → *Example*

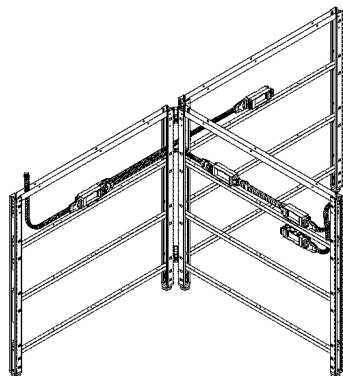

### GROMMETS (TAKE OFF COLLECTIONS)

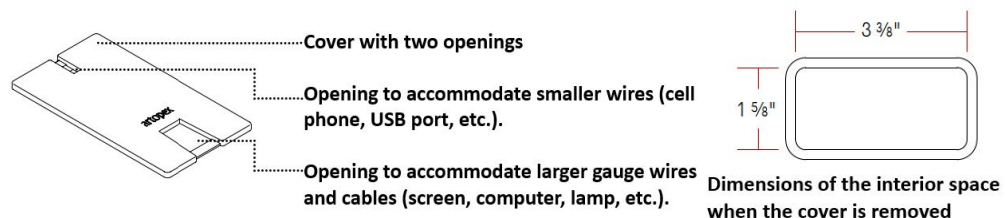

### CABLE GROMMET (AXELSURFACES)

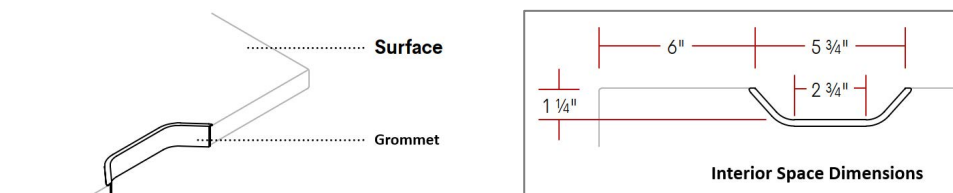

### COMMUNICATION PLATE (DATA)

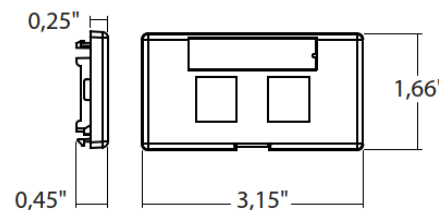
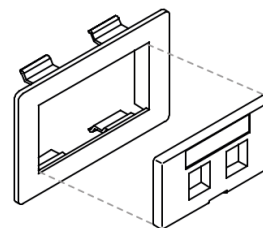

#### Communication Plate

Can accommodate 2 communication ports.  
 Openings: 5/8" x 9/16".  
 Communication ports are not included. Includes a plate for 2 communication ports and the associated finishing plate.  
 Model: LEVITON 49910-SX2

Laminates  
Laminés

01

Specifications  
Spécifications

This is  
where ideas  
take flight.  
C'est ici  
que des idées  
décolleront.

01

Colors Couleurs	Finishes Finis	Codes
Black / Noir *	Dolomite	N
Carbon / Carbone	Aura	CB
Cayenne Maple / Érable de cayenne	Suede	CM
Charcoal / Fusain	Dolomite	F
Cherry / Cerisier	Suede	CH
Chestnut / Châtaigne	Supermat	CG
Dalia	Aura	DA
First Class / Première classe	Karisma	ST
Free Spirit / Esprit libre	Karisma	EL
Frost / Grès	Dolomite	A
Galaxy / Galaxie	Aura	GX
Ginger Root / Gingembre	Aura	GG
Honey / Miel	Suede	HO
Lago	Supermat	LA
Maritime Maple / Érable maritime	Supermat	EM
Moka	Supermat	PM
Sea Salt / Sel de mer	Aura	SM
Sesame / Sésame	Aura	SE
Sheer Beauty / Beauté naturelle	Karisma	BN
Tobacco Cherry / Cerisier tabac	Supermat	TC
White / Blanc	Dolomite	BW
Willow Grey / Gris saule **	Supermat	WG

\* Black is not available as a TOP color. / Le noir n'est pas disponible en tant que couleur de SURFACE.

\*\* Willow Grey in H.P.L. has a MAT finish, not supermat. / La couleur Gris saule en stratifié a un fini MAT, et non supermat.

artopex®

artopex®

Head office/Siège social  
800 Vadnais, Granby QC  
J2J 1A7 CANADA  
T 450 378 0189/1 800 363 3040  
F 450 378 9712  
artopex.com

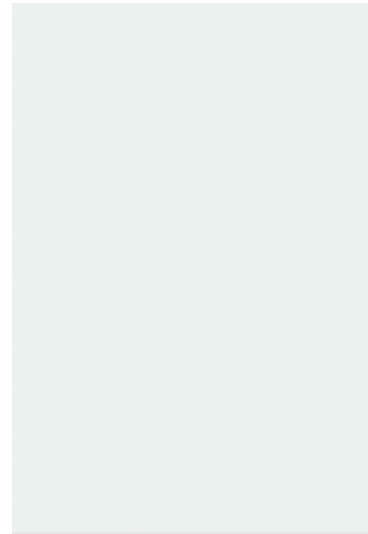

White / Blanc  
**BW**



Frost / Grès  
**A**



Willow Grey / Gris saule  
**WG**



Lago  
**LA**

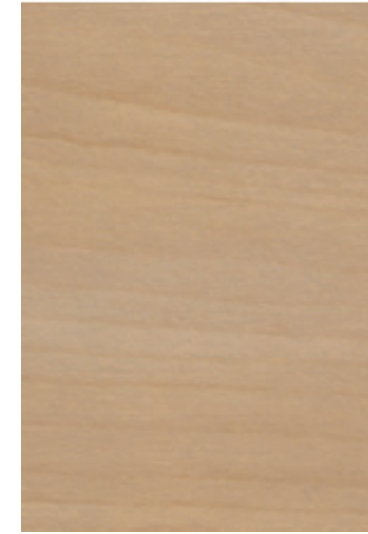

Maritime Maple / Érable maritime  
**EM**



Honey / Miel  
**HO**



Tobacco Cherry / Cerisier tabac  
**TC**



Cherry / Cerisier  
**CH**



Sea Salt / Sel de mer  
**SM**



Free Spirit / Esprit libre  
**EL**



Sheer Beauty / Beauté naturelle  
**BN**



Ginger Root / Gingembre  
**GG**



First Class / Première classe  
**ST**



Cayenne Maple / Érable de cayenne  
**CM**



Galaxy / Galaxie  
**GX**



Sesame / Sésame  
**SE**



Moka  
**PM**



Dalia  
**DA**



Chestnut / Châtaigne  
**CG**



Carbon / Carbone  
**CB**

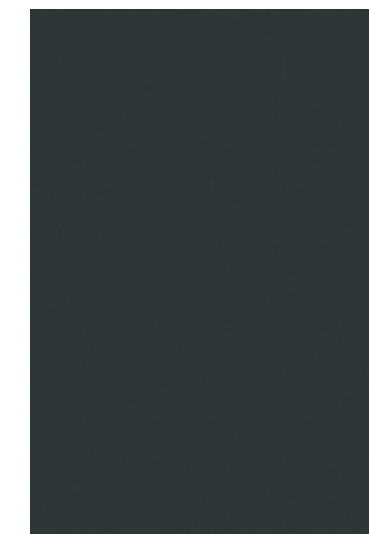

Charcoal / Fusain  
**F**



Black / Noir  
**N**

# Hypermat

FENIX® H.P.L. and Hypermat Enamel  
Stratifié FENIX® et Émail Hypermat

01<sup>h</sup>

01<sup>h</sup>

artopex®

**FENIX® H.P.L.  
Stratifié FENIX®**

**Hypermat Enamel  
Émail Hypermat**

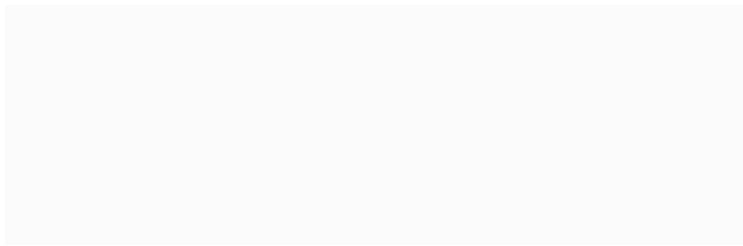

Bianco Kos  
**BK**

Bianco Kos  
**3488**



Grigio Londra  
**GL**

Grigio Londra  
**3486**

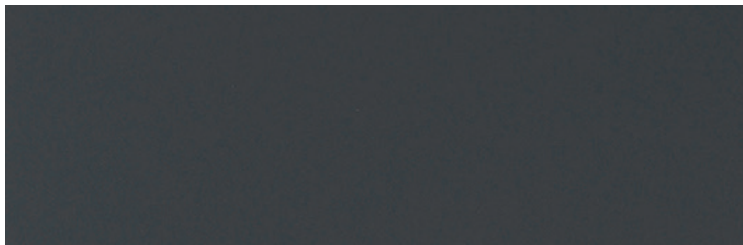

Grigio Bromo  
**GB**

Grigio Bromo  
**3485**

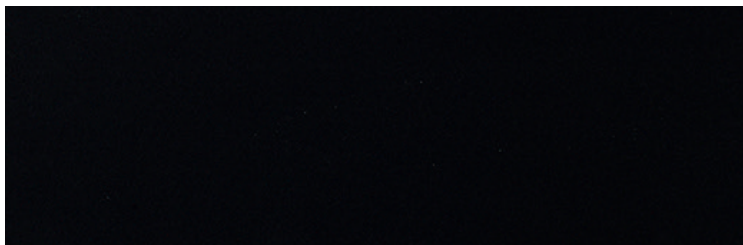

Nero Ingo  
**FN**

Nero Ingo  
**3487**

FENIX® H.P.L. use nanotechnology for a distinctive tactile experience. Ultra-soft and light-absorbing, this finish is also scratch resistant. Marks disappear on their own through thermal regeneration. The smooth surface of FENIX® H.P.L. is easily cleaned and disinfected. Hypermat Enamel colors match the FENIX® H.P.L. colors but retain the properties of standard Artopex enamel finishes.

Les finis stratifiés FENIX® utilisent la nanotechnologie afin d'offrir une expérience unique au toucher. Ultra-doux et absorbant la lumière, ce fini résiste également aux égratignures. Les rayures disparaissent d'elles-mêmes grâce à une régénération thermique. Avec leur surface lisse, les FENIX® peuvent être nettoyés et désinfectés aisément. Les couleurs des finis Émail Hypermat correspondent à celles des stratifiés FENIX®, mais conservent les propriétés des autres finis d'émail Artopex.



Enamel  
Émail

02

This is  
where ideas  
take flight.

C'est ici  
que des idées  
décolleront.

02

artopex®

artopex®

Head office/Siège social  
800 Vadnais, Granby QC  
J2J 1A7 CANADA

T 450 378 0189/1 800 363 3040  
F 450 378 9712  
[artopex.com](http://artopex.com)

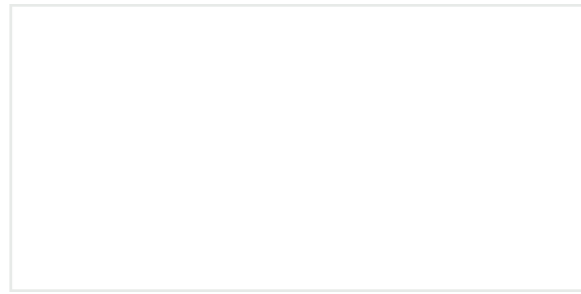

Polar White / Blanc polaire  
ARTOPEX - 3002

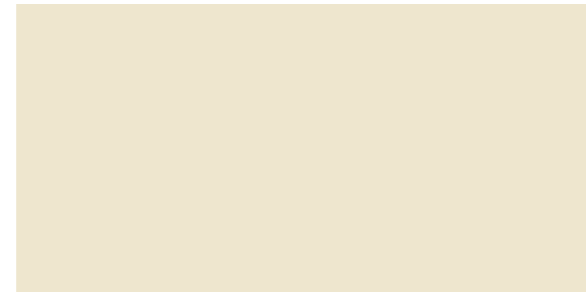

Antique White / Blanc antique  
ARTOPEX - 3004



Lemon / Citron  
ARTOPEX - 3104



Cactus  
ARTOPEX - 3105



Suede / Suède  
ARTOPEX - 3023



Espresso  
ARTOPEX - 3076



Silver / Argent  
ARTOPEX - 3090 \* Standard prices / Prix standards

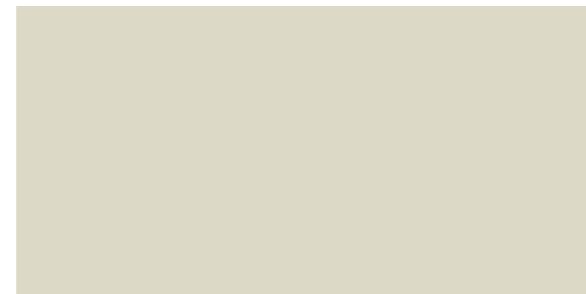

Eggshell / Coquille d'oeuf  
ARTOPEX - 3005

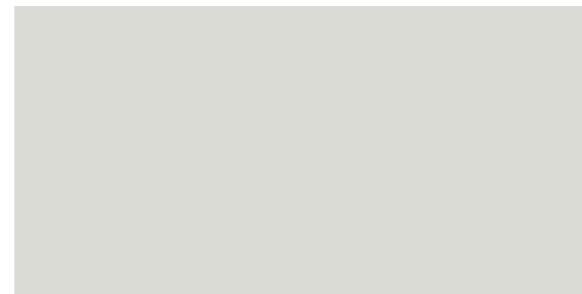

Fossil / Fossile  
ARTOPEX - 3102



Abyss / Aysse  
ARTOPEX - 3113

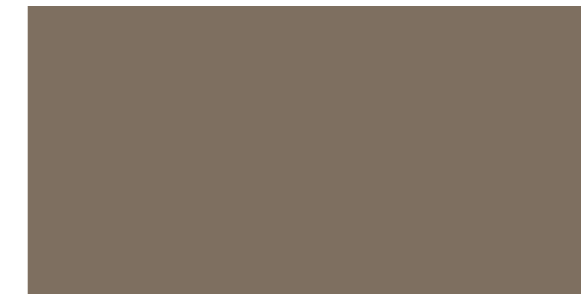

Mocha - Moka  
ARTOPEX - 3075

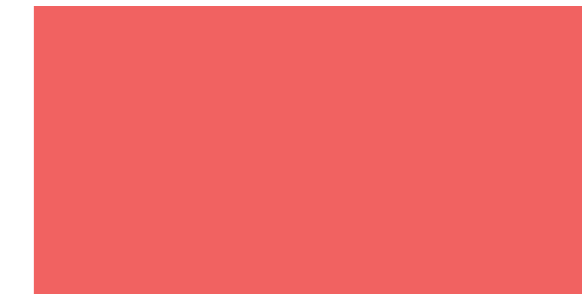

Smoothie  
ARTOPEX - 3109



Champagne  
ARTOPEX - 3311 \*\* Metallic prices / Prix métalliques



Sand / Sable  
ARTOPEX - 3009



Frost / Grès  
ARTOPEX - 3065



Source  
ARTOPEX - 3106



Mimosa  
ARTOPEX - 3114



Poppy / Coquelicot  
ARTOPEX - 3110

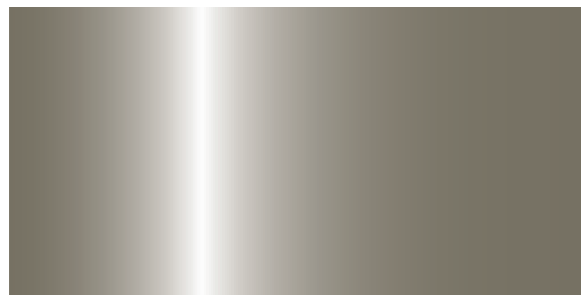

Ashen / Cendré  
ARTOPEX - 3370 \*\* Metallic prices / Prix métalliques



Warm Grey / Gris chaud  
ARTOPEX - 3061



Grey / Gris  
ARTOPEX - 3063



China Blue / Bleu Chine  
ARTOPEX - 3048



Amber / Ambre  
ARTOPEX - 3108



Cherry / Cerise  
ARTOPEX - 3111



Black / Noir  
ARTOPEX - 3067



Shadow / Ombre  
ARTOPEX - 3101



Charcoal / Fusain  
ARTOPEX - 3064

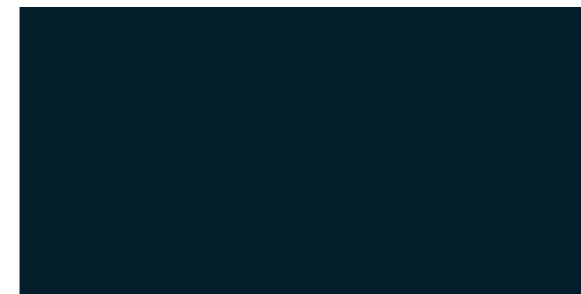

Navy / Marine  
ARTOPEX - 3050



Tangerine  
ARTOPEX - 3020



Grenadine  
ARTOPEX - 3044

# Moodboard

## PROPOSED COLOR SCHEMES / PROPOSITION D'AGENCEMENT DE COULEURS

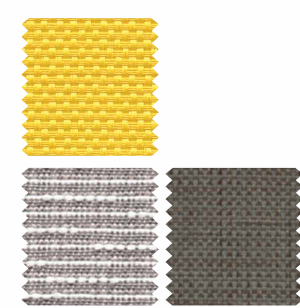

Effective July 25<sup>th</sup>, 2016  
En vigueur le 25 juillet 2016

# textiles

## PANELS / PANNEAUX

SPECIFICATION / SPÉCIFICATIONS	WHISPER II*	NETIQUETTE	STRATA	CRYSTALLINE	CASCADE
Composition	53% Recyc. - PC 100% Polyester	31% Recyc. - PC 100% Polyester	100% Recyc. - PC 100% Polyester	100% Recyc. - PC 100% Polyester	100% Recyc. - PC 100% Polyester
Weight-linear yard / Poids-verge linéaire	10.9 oz	9.6 oz	10 oz	11 oz	11 oz
Width / Largeur	68"	66"	67"	67"	67"
<b>PERFORMANCE / PROPRIÉTÉS</b>					
Tensile strength / Résistance à la rupture	Warp : 274 lbs Fill : 150 lbs	Warp : 259 lbs Fill : 132 lbs	Warp : 100 lbs Fill : 100 lbs	Warp : 100 lbs Fill : 100 lbs	Warp : 100 lbs Fill : 100 lbs
Color fastness to light / Résistance à la lumière	40hrs. Class/Classe 4.5	40hrs. Class/Classe 4	40hrs. L5	40hrs. L5	40hrs. L5
Color fastness to crocking AATCC 8 / Résistance au dégorgeage AATCC 8	Dry / Sec : Class 5 Wet / Humide: Class 5	Dry / Sec : Class 5 Wet / Humide: Class 5	Dry / Sec : Class 5 Wet / Humide: Class 5	Dry / Sec : Class 5 Wet / Humide: Class 5	Dry / Sec : Class 5 Wet / Humide: Class 5
Abrasion resistance / Résistance à l'abrasion	ASTM D-4157 100 000 D.R. / D.F.	ASTM D-4157 50 000 D.R. / D.F.			
Cleaning code / Nettoyage	WS	WS	WS	WS	WS
Acoustic textiles / Tissus acoustiques	Yes / Oui	Yes / Oui			
<b>FLAMMABILITY / INFLAMMABILITÉ</b>					
ASTM E-84	Class 1 or A	Class 1 or A	Class 1 or A	Class 1 or A	Class 1 or A
California - Tech. bulletin 117 Sec. E (CS-191-53) Californie - Bulletin tech. 117 Sec. E (CS-191-53)	Passes Passe	Passes Passe			
<b>SAMPLING CONTACT / ÉCHANTILLON</b>	victortextiles.com (418) 227-9897	victortextiles.com (418) 227-9897	artopex.com (800) 363-3040	artopex.com (800) 363-3040	artopex.com (800) 363-3040

SPECIFICATION / SPÉCIFICATIONS	OFF THE GRID*	DASHING	ESSENCE	PACT	UNIVERSE	CAPE COD
Composition	87% Recyc. 49% Pl, 38% PC 100% Polyester	100% Recyc. 100% Polyester	100% Polyester	100% Recyc. 65% Pl, 35% PC 100% Polyester	50% Recyc. - PC 100% Polyester	100% Recyc. 76% Pl, 24% PC 100% Polyester
Weight-linear yard / Poids-verge linéaire	10 oz	10.9 oz	11.8 oz	12.9 oz	11.7 oz	12.4 oz
Width / Largeur	67"	66"	66"	66"	66"	66"
<b>PERFORMANCE / PROPRIÉTÉS</b>						
Tensile strength / Résistance à la rupture	Warp : 188 lbs Fill : 169 lbs	Warp : 240 lbs Fill : 191 lbs	Warp : 140 lbs Fill : 105 lbs	Warp : 292 lbs Fill : 307 lbs	Warp : 137 lbs Fill : 190 lbs	Warp : 150 lbs Fill : 150 lbs
Color fastness to light / Résistance à la lumière	40hrs. Class/Classe 4	40hrs. Class/Classe 4	40hrs. L5	40hrs. Class / Classe 4	40hrs. Class / Classe 4	40hrs. Class / Classe 4
Color fastness to crocking AATCC 8 / Résistance au dégorgeage AATCC 8	Dry / Sec: Class 5 Wet / Humide: Class 5	Dry / Sec: Class 4 Wet / Humide: Class 4	Class/Classe 4	Dry / Sec: Class 4.5 Wet / Humide: Class 4.5	Dry / Sec: Class 5 Wet / Humide: Class 5	Dry / Sec : Class 4 Wet / Humide: Class 3
Abrasion resistance / Résistance à l'abrasion	ASTM D-4157 100 000 D.R. / D.F.	ACTM D-4157 Mod. 60 000 D.R. / D.F.	ASTM D-4157 Mod.	50 000 D.R. / D.F.		
Cleaning code / Nettoyage	WS	WS	WS	WS	WS	WS
Acoustic textiles / Tissus acoustiques						Yes / Oui
<b>FLAMMABILITY / INFLAMMABILITÉ</b>						
ASTM E-84	Class 1 or A	Class 1 or A	Class 1 or A	Class 1	Class 1 or A	Class 1 or A
California - Tech. bulletin 117 Sec. E (CS-191-53) Californie - Bulletin tech. 117 Sec. E (CS-191-53)	Passes Passe	Passes Passe	Passes Passe	Passes Passe		
<b>SAMPLING CONTACT / ÉCHANTILLON</b>	victortextiles.com (418) 227-9897	victortextiles.com (418) 227-9897	victortextiles.com (418) 227-9897	memosamples.com (800) 366-6839	memosamples.com (800) 366-6839	guilfordofmaine.com (800) 544-0200

\* OFF THE GRID - lava OF05, thermal OF06 / WHISPER II- dim WH76, peep WH91.  
These four colours are not recommended with the TakeOff System.  
Ces quatre couleurs ne sont pas recommandées avec le SystèmeTakeOff.

### Graded-in and pre-tested fabrics

In order to offer a wide selection of fabrics, a list of fabrics graded-in and pre-tested by Artopex (in various grades) is available at artopex.com. Please refer to the websites of the fabric manufacturers and distributors on this list to view the choices and/or to order samples of complementary fabrics.

### Tissus pré-gradés et pré-testés

Dans le but d'offrir une grande variété de tissus, une liste de tissus pré-gradés et pré-testés par Artopex (incluant divers grades) est disponible sur le artopex.com. Veuillez vous référer au site internet des différents fabricants et distributeurs de tissus présentés sur cette liste afin de visualiser les choix offerts et/ou commander des échantillons pour ces tissus complémentaires.

Colours may vary from the actual colours due to the printing process used.  
Please refer to samples for true colours.  
Les couleurs sont aussi fidèles que les techniques d'impression le permettent.  
Référez-vous aux échantillons pour les couleurs réelles.



**HEAD OFFICE / SIÈGE SOCIAL**  
800, rue Vadnais  
Granby, Qc  
J2J 1A7, CANADA

T: 450 378-0189  
1 800 363-3040  
F: 450 378-9712

artopex.com





## **Brume (FE11)**

### **Type**

Felt

### **Composition**

Polyester

### **Abrasion**

### **Patron**

### **Color**

Black

### **Supplier**

### **Grade**

### **Treatment**

Fire Classification- Class C

### **Recycled Material**

Contains recycled material

### **Programs**

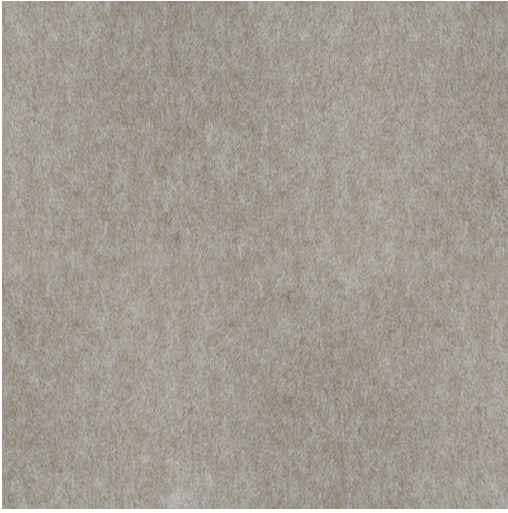

## **Dune (FE12) - NOUVEAU**

### **Type**

Felt

### **Composition**

Polyester

### **Abrasion**

### **Patron**

### **Color**

Beige

### **Supplier**

### **Grade**

### **Treatment**

Fire Classification - Class C

### **Recycled Material**

Contains recycled material

### **Programs**



## **Ombre (FE03)**

### **Type**

Felt

### **Composition**

Polyester

### **Abrasion**

### **Patron**

### **Color**

Black

### **Supplier**

### **Grade**

### **Treatment**

Fire Classification - Clas C

### **Recycled Material**

Contains recycled material

### **Programs**

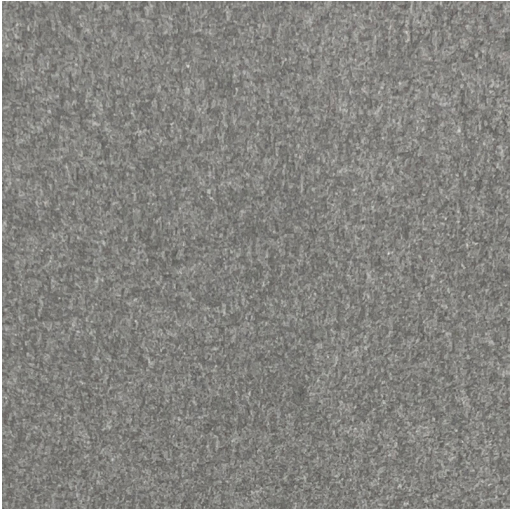

## **Orage (FE36)**

### **Type**

Felt

### **Composition**

Polyester

### **Abrasion**

### **Patron**

### **Color**

Gray

### **Supplier**

### **Grade**

### **Treatment**

Fire classification - Class C

### **Recycled Material**

Contains recycled material

### **Programmes**

*L'art de concevoir, fabriquer,  
de conseiller, d'aménagement et de servir  
- distingue la manière Artopex*

**GRANBY | Bureau chef**

800, rue Vadnais  
Granby (Québec) J2J 1A7  
Canada  
Tél : 1-800-378-0189  
Préparé par: N.C.

